

建 境影响 告

2021

一、基 况

	/		
			02 2
	1		
	11	.22	32 1 2 .3
	12		32 33 3 1
			<input type="checkbox"/>
/			/
	0		1
%	2 %		/
	<input type="checkbox"/>	2	1000

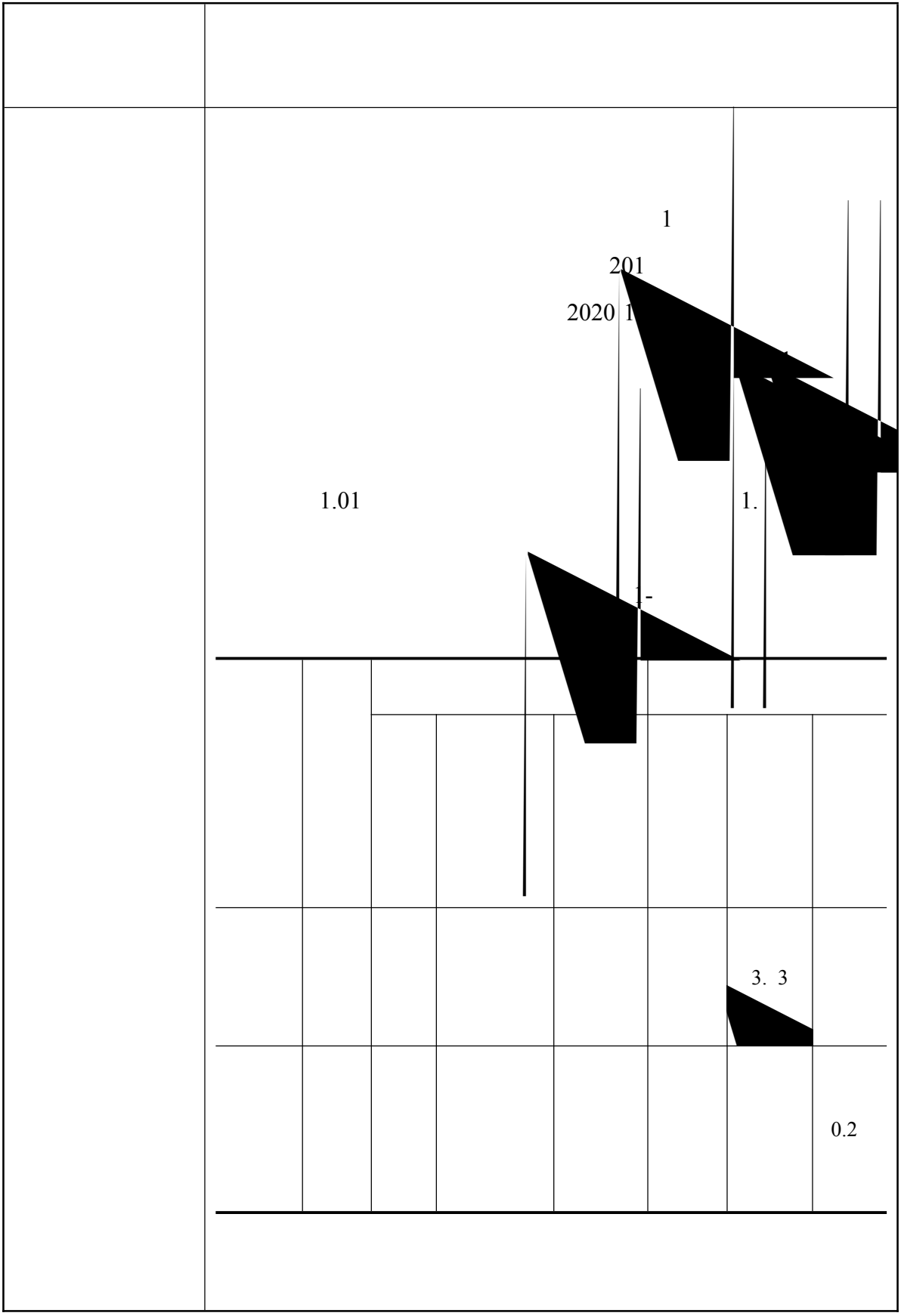

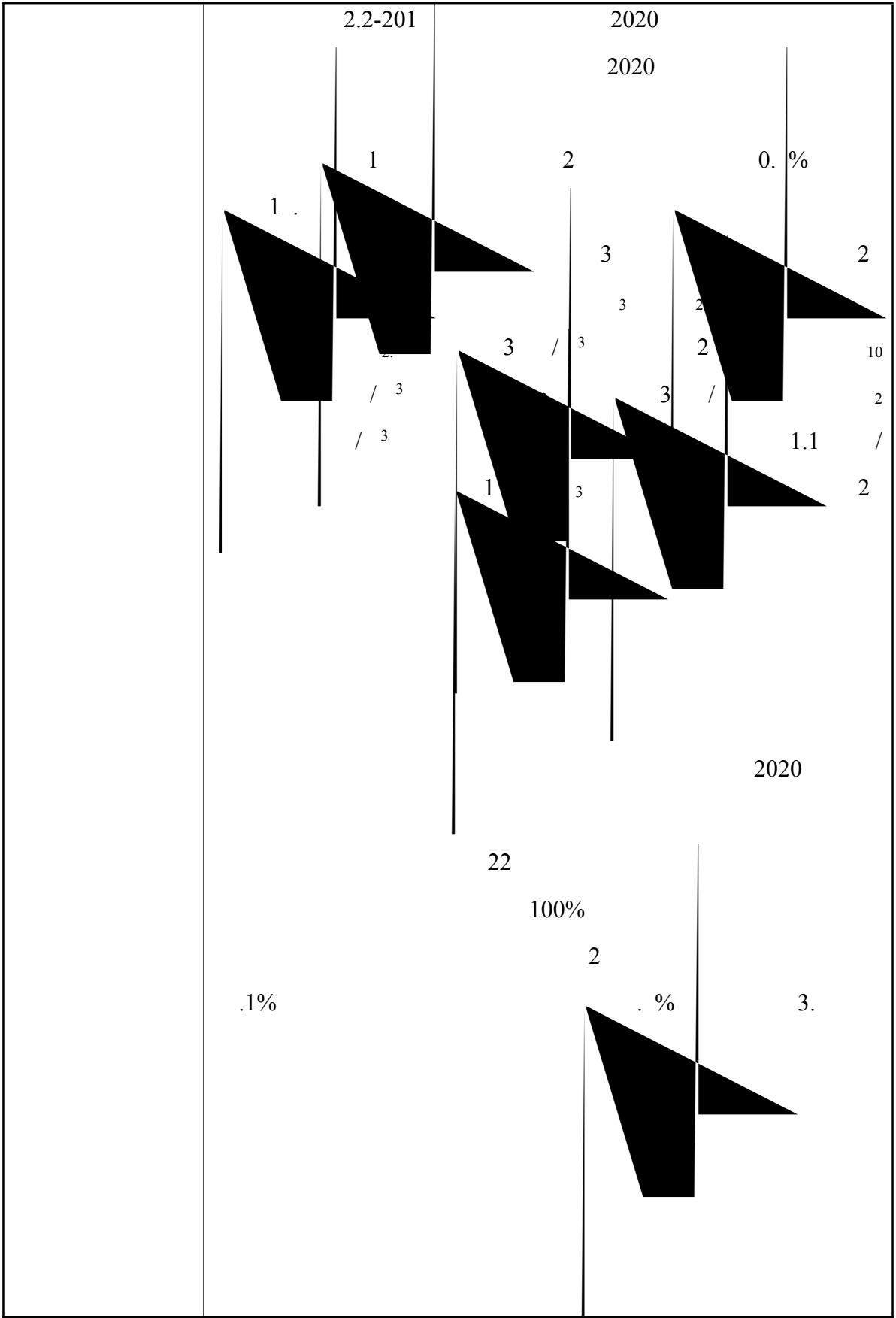



1-2

			30 -2012 201 2
			3 3 -2002
		2	30 -200

1

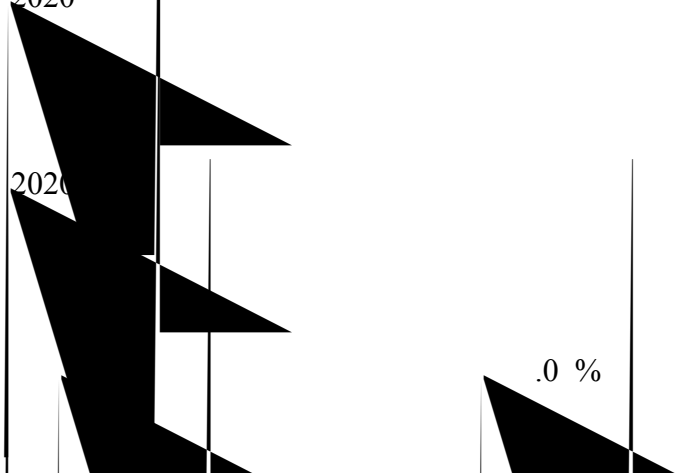

	2020		1-3	
1	201	2	201	
2		2012	2013	2013
3		2012	2012	2012
	(2013)	(2013)	(2013)	(2013)
		2020		2020
	201 2 1			
		2020		
		1-		

	1	1
	2 1	
	3	
		1
	1	
	2	
	3	
		
		

2020

2020

.0 %

--	--

		3/	
		2 3/	
		/	
		/	
		3 2	
		+ +	
			1 3-2001
			1 2 -1
		-	
		10 2	
		2	

1		0 /	2
2		2 0 00 1000 /	1 00
3		100 /	21
		/	1
		2 /	
		00 /	10
		20 /	2
		20 /	10
		0 /	
10		1 /	2 00
11		/	103
12		10 /	21
13		/	1 00
1		1 /	2 00
1		/	3 00

1		/	/	0.1	
---	--	---	---	-----	--

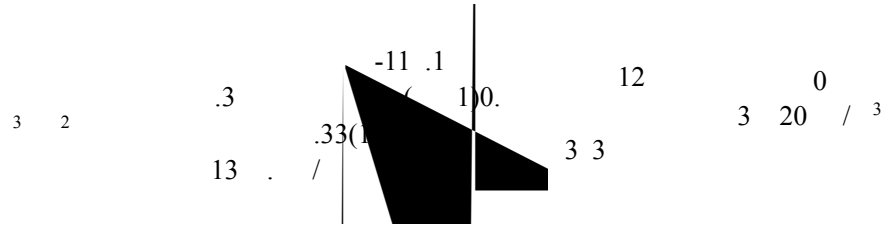

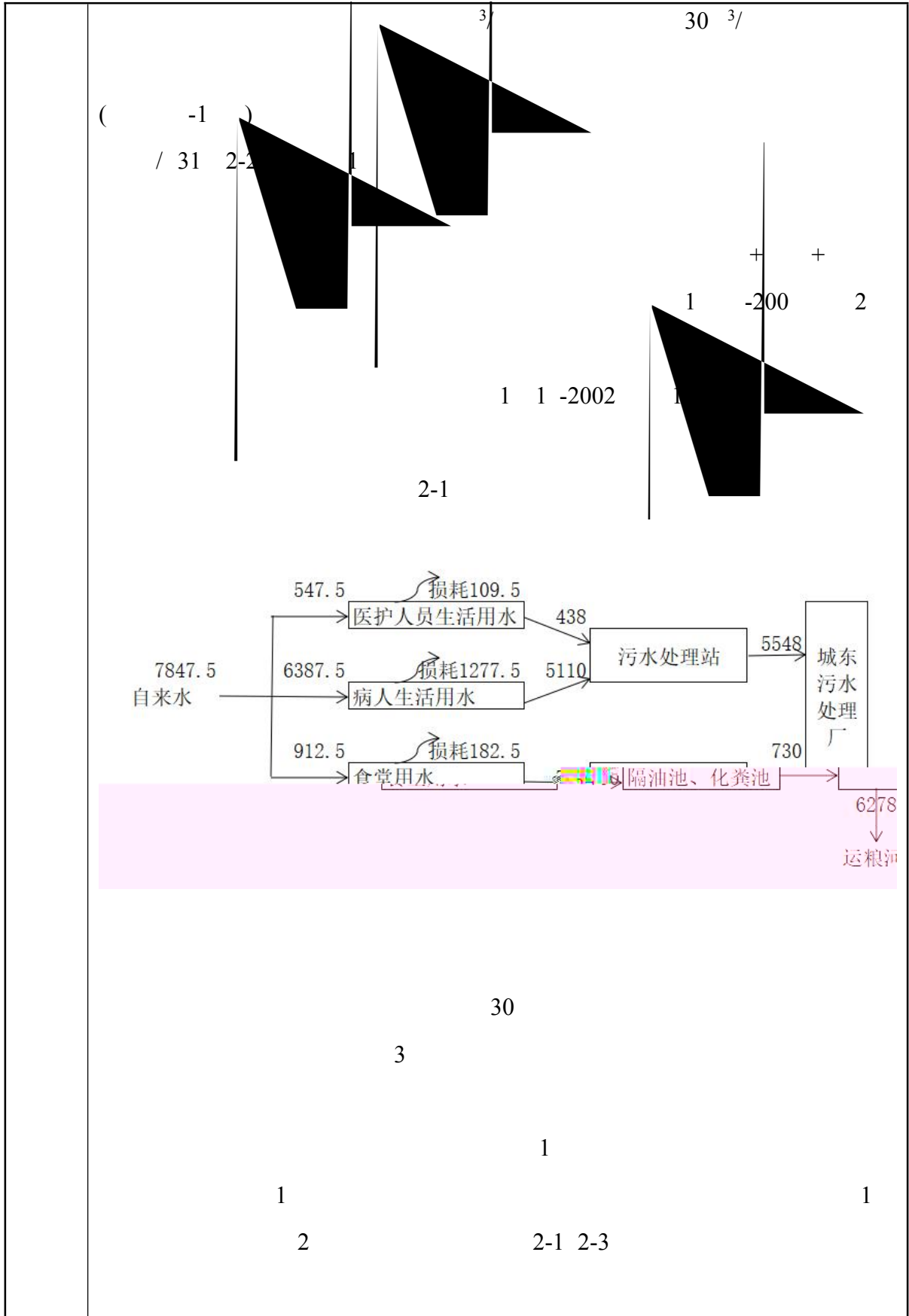

2-1

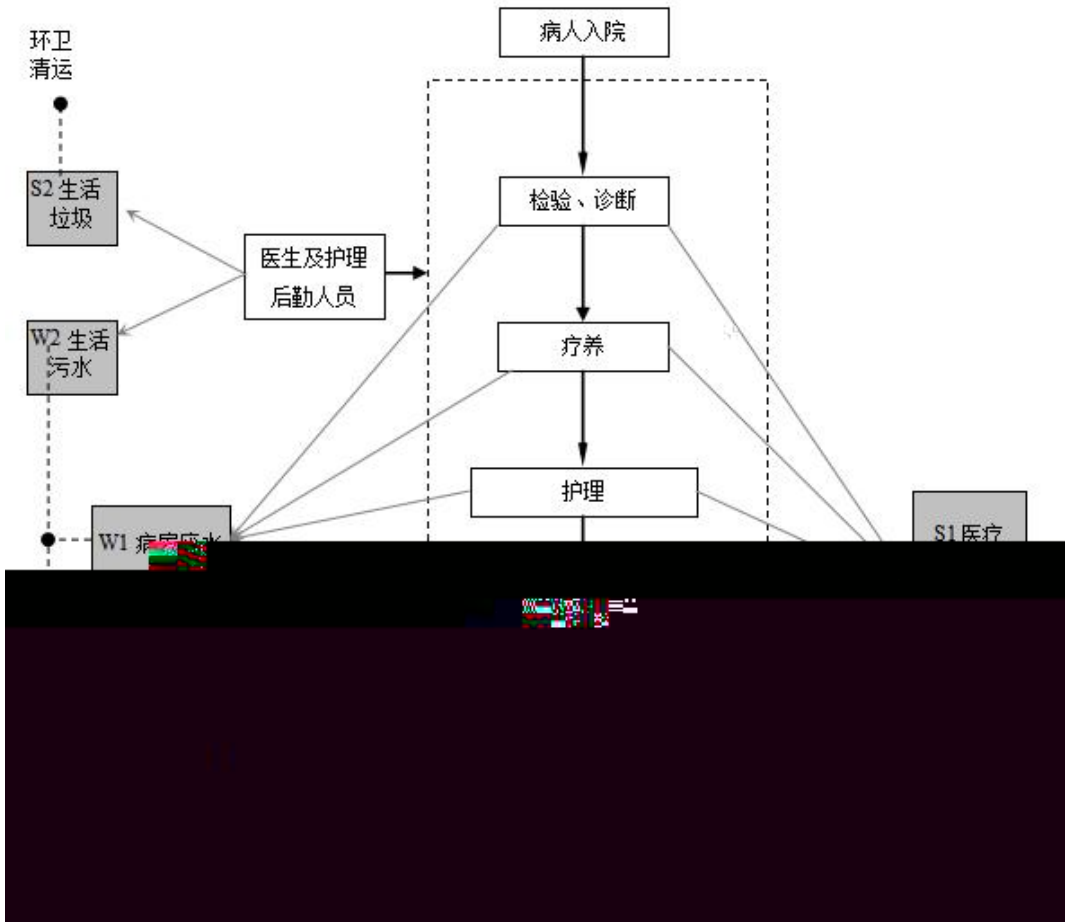

1

2

3

1

	1

三、区域 境 、 境保 及 价 准

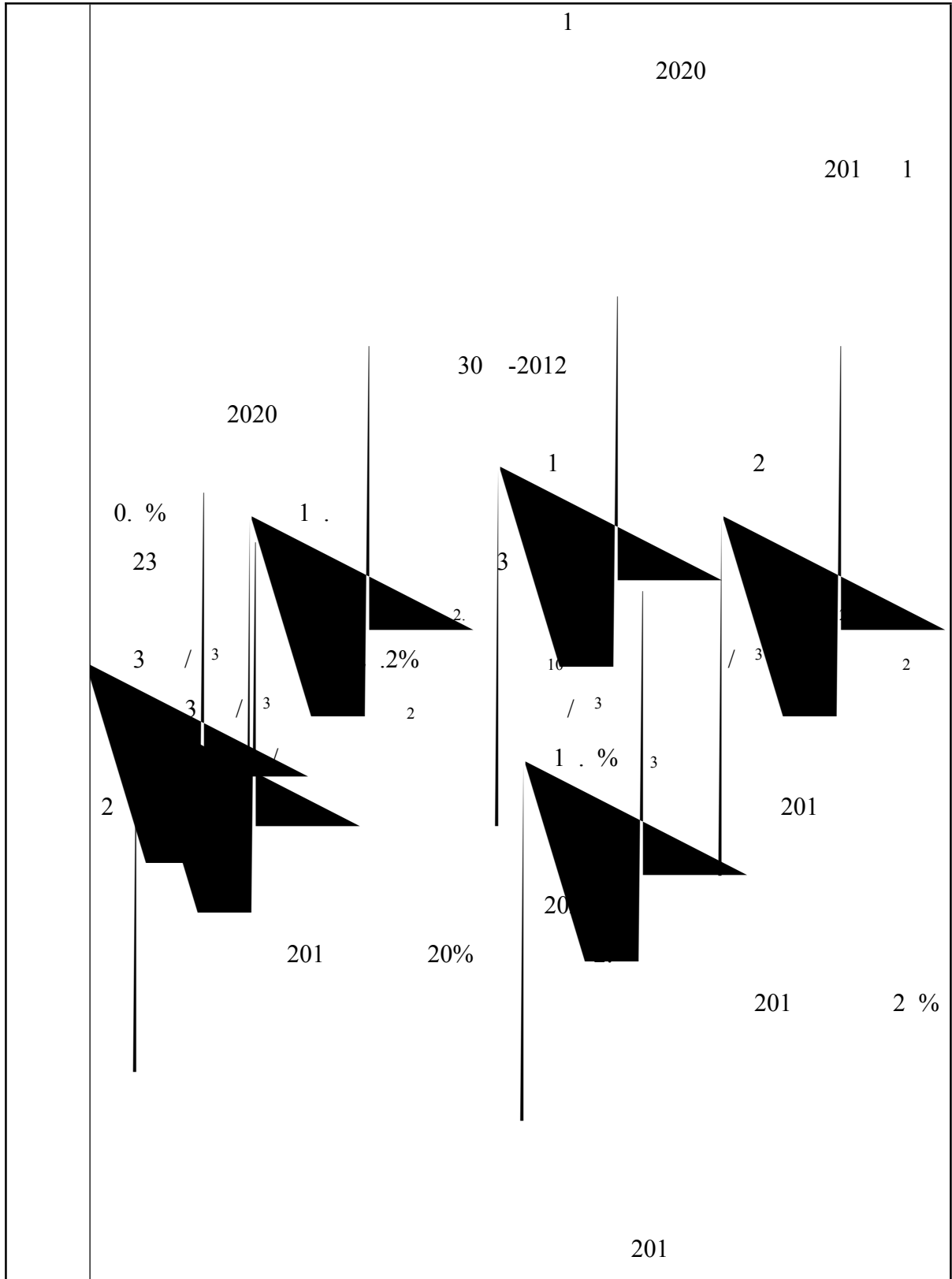

1

201

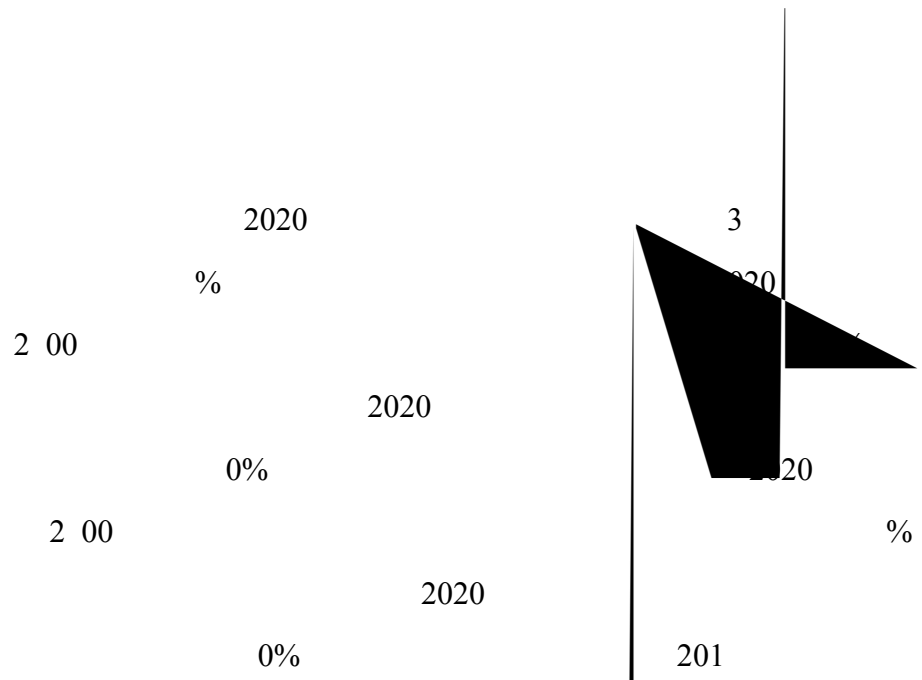

2020

11%

2020

0%

2.

2020

20%

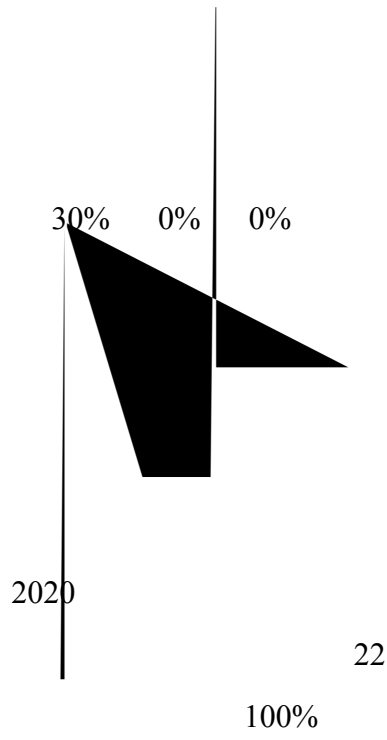

2021.2.	1		13	31	13	1	0.	00	32	00	2	.3
	2		13		13		1.1	00		00		.

3 1 13  1 0 |

				1.01	3. 3	
				1.	0.2	
<p>1 2 -1</p> <p style="margin-left: 150px;">3-</p> <p style="margin-left: 100px;">1 3-2001</p> <p style="margin-left: 170px;">3-</p>						
1		2		0. 2	0	1 2 -1
<p style="margin-left: 200px;"> </p> <p style="margin-left: 350px;"> </p>						
	1 3	2.0	0			

				1	3-2001
	3				
<p>(-1)</p> <p>/ 31 2-201</p> <p>+ +</p> <p>1 -200 2</p> <p>1</p> <p style="text-align: right;">1 1 -2002</p> <p>3-</p>					
		-			
		2 0			
		0		1	-200 2
		000 /			
<p>(-1)</p> <p>(/ 31 2-201)</p> <p>100</p>					
1			-		
2			0		

			10	
3			1	
			()*	
			1.0	
			0.	
			10 ³ /	
	123	-200	2	3-
			0	0
	1	-2001	2013	3
	1			2021
	1	-2020)		(
			2013	3
				1
				-2001
		201	32	
	2000	120		2010
				1

10

3-10

	0.03	0.0323	-	0.001
	0.0	0.0	-	0.00 1
	2	0	2	2
	1.	0. 13	1.3 1	0.32 2
	1.01	0. 3	0.	0.0 2
	0.2	0.0 0	0.1 3	0.0 2
	0.1	0.0	0.101	0.031
	0.032	3 0	0.032	0.0032
	0.0	0.032	0.032	0.000
	1. 10 ¹	1.3 2 10 ¹	2. 10 ¹⁰	. 10
	3 .	3 .	-	0
	10.	10.	-	0
	0.110	0.110	-	0
			-	0
	0.	0.	-	0
	0.1 1	0.1 1	-	0
	.	.	-	0
	2.0	2.0	-	0

1

2

3

0.101 /

0.032 /

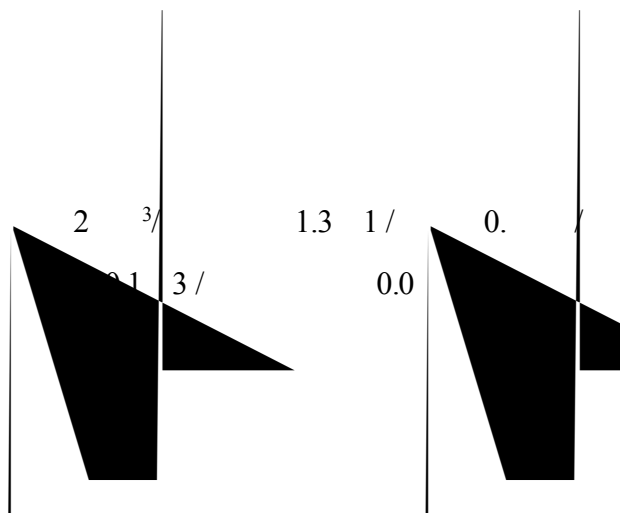

. 10 /

四、主 境 响和保

1

	.1			0.2	.1

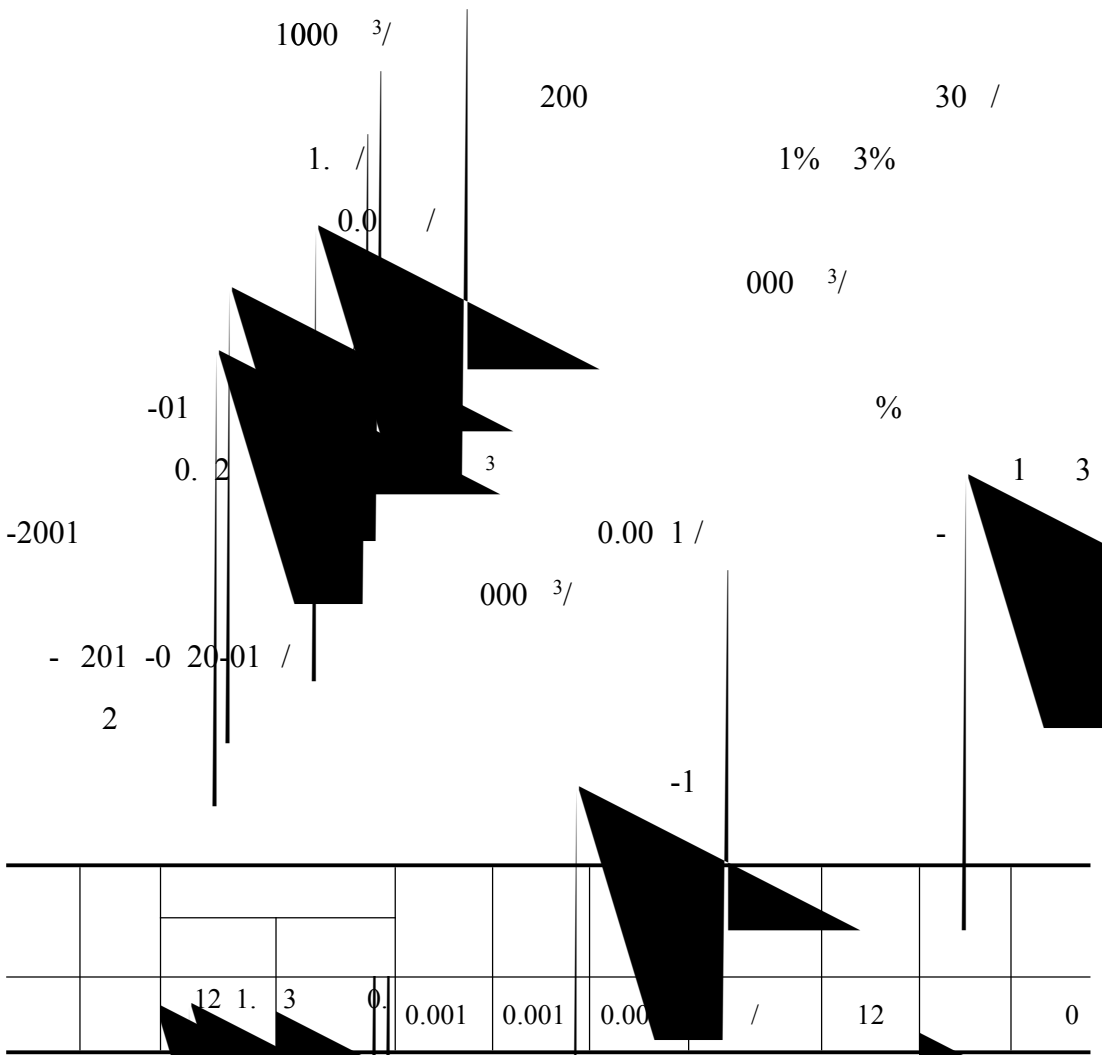

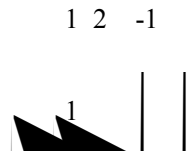
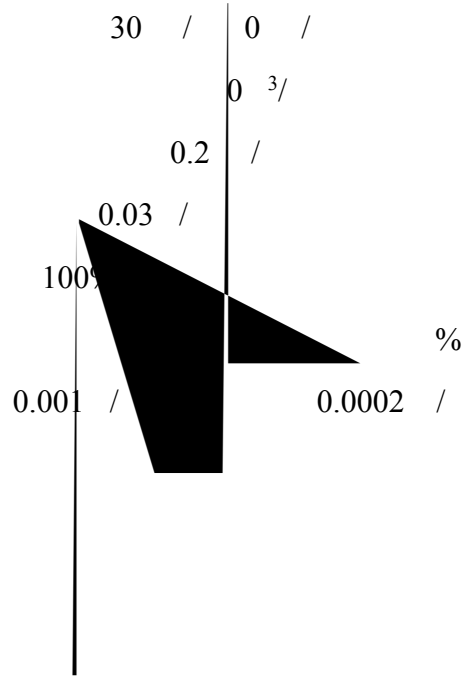
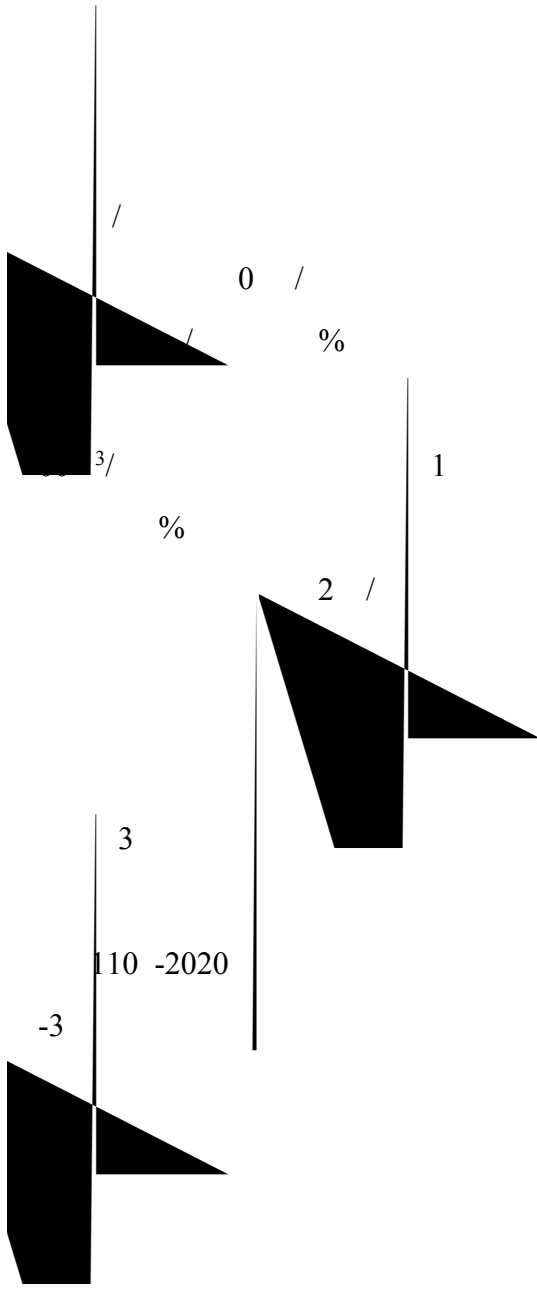

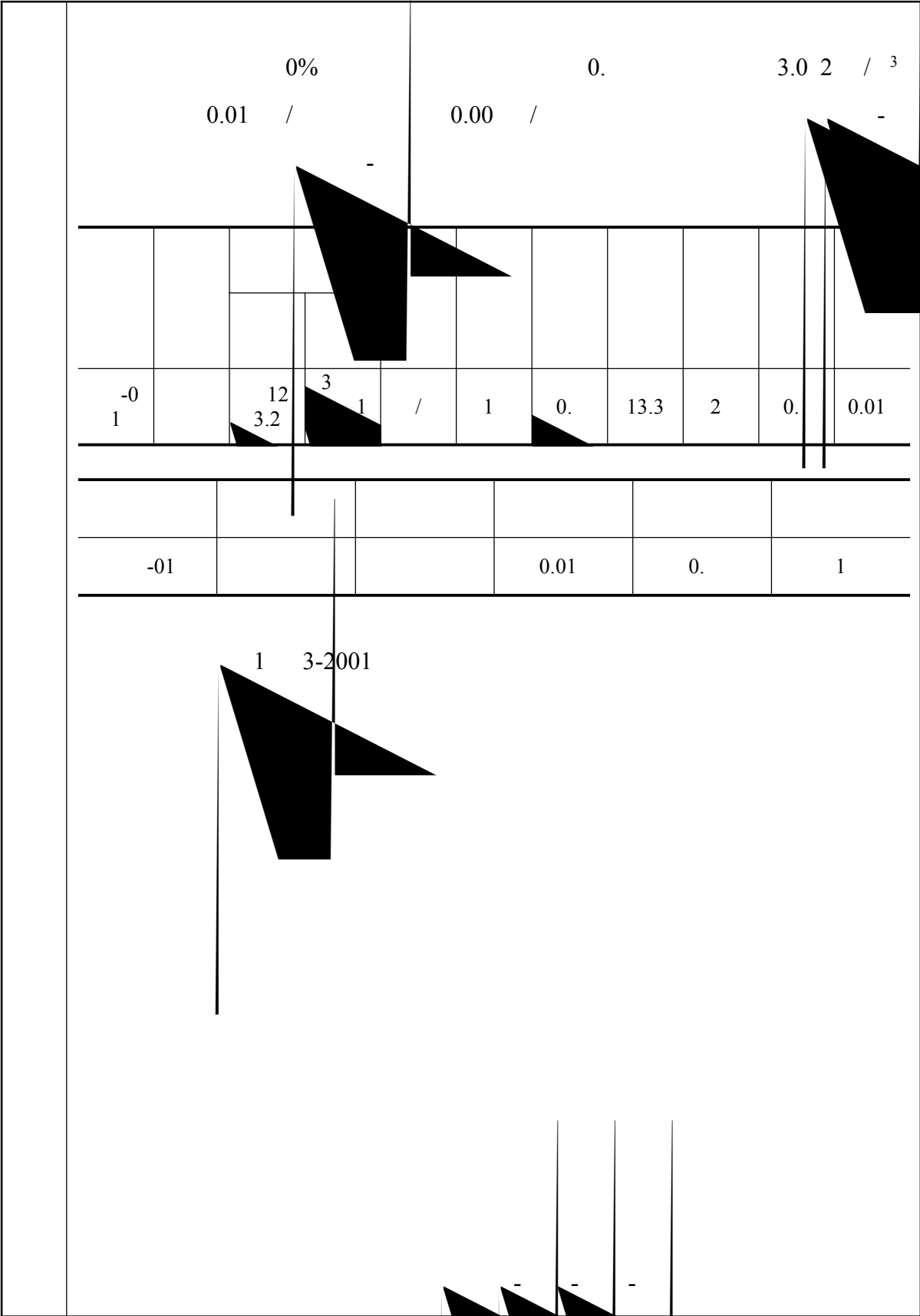

1					1 2 -1	0.		0.001
					0.001			
1					0.001			
2					0.00 1			
				μ				
1	01			$3.0 \cdot 2 \cdot 10^3$	0.01	0.	1	
					1	2020		
					3	2	2.	
(30 -2012)								
					-01			
					1			
					30			

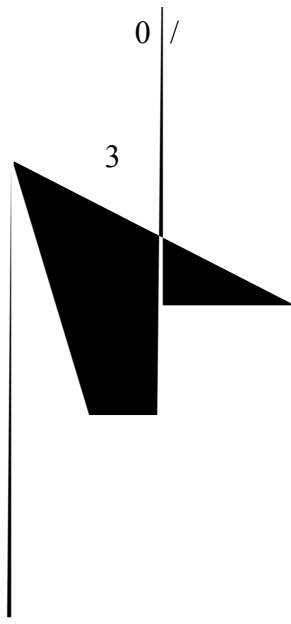
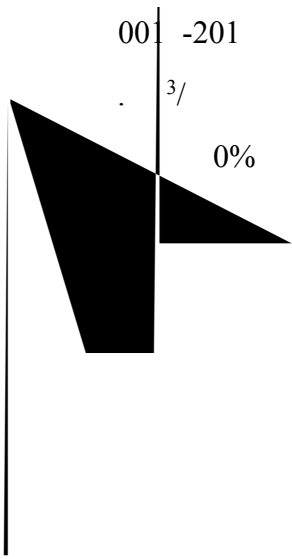

3
031 -201

30 ^{3/}		00	0.2 2	+	3 0	0.2	0	0.03
		2 0	0.1 2		200	0.1	10	0.00 3
			0.032			0.032	1	0.011
		2	0.01 3		2	0.01 3		0.003
			0.00 1			0.00 1	0.	0.000
		0	0.0			0.032	1.0	0.000

3

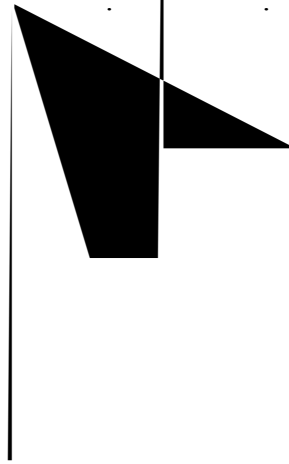

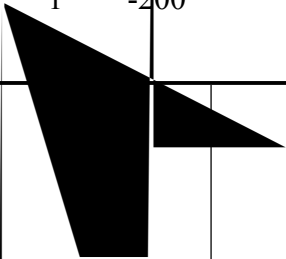
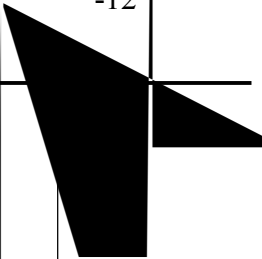
3									
		1 -200				110 -2020 -12			
									
1							/	/	/
2	1#							12	/ 20
3									/ 11 1 -1
			/	/	/	/	3		-
									/ 11 01-1

										/ 11 3-1
										3 -2012
										3 .1-201
										3 -201
1 0	2#			/	/	/	/	2		/ 11 1 -1
1 1										/ 11 01-1
									3	3
									1	/
	1									

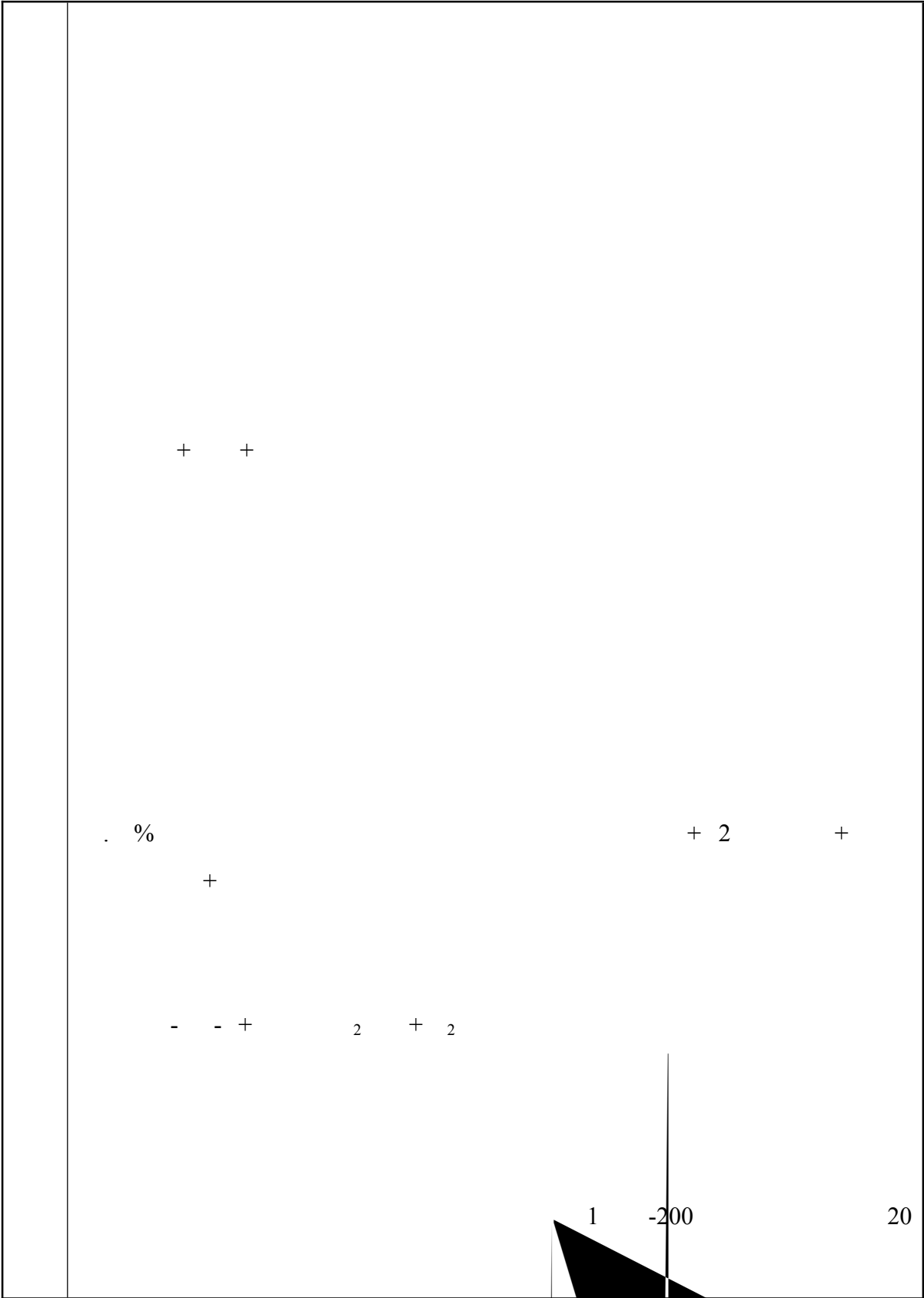

(1 1 -2002)

2 3/ 1 .2 3/
3 / 0.00 %

+ +

+ +

1

0 ()

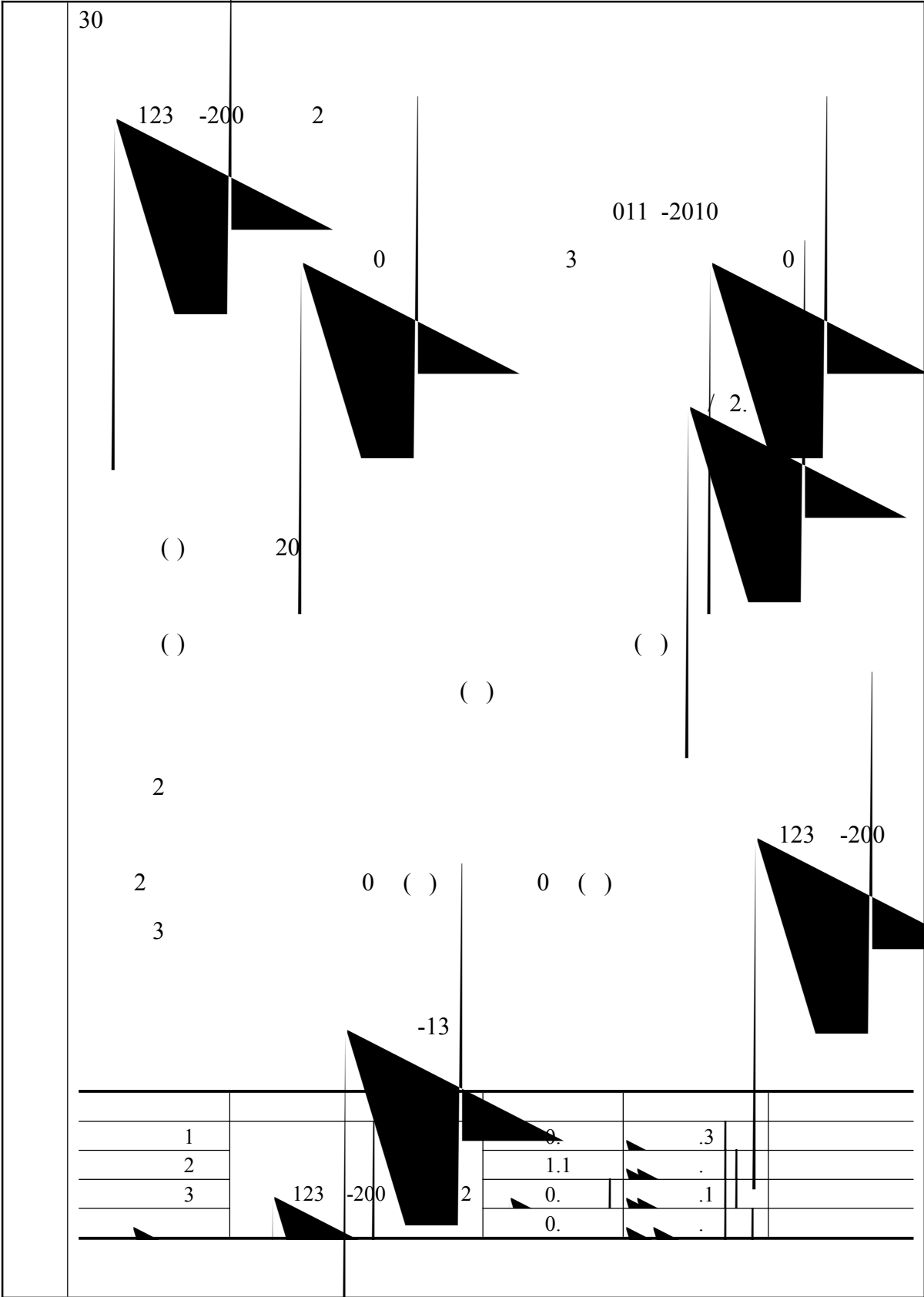

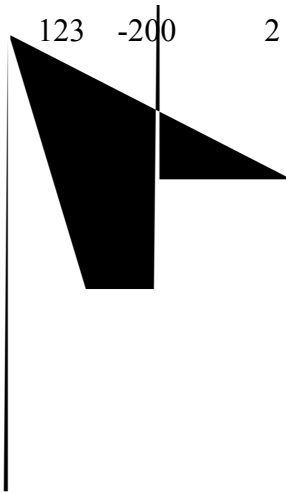
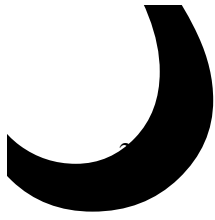

1

1

30

1 /

0

1.0 / .

3 . /

2

0.3 /

100

10. /

3

0.0

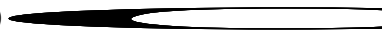

2' P' u

3

0. /

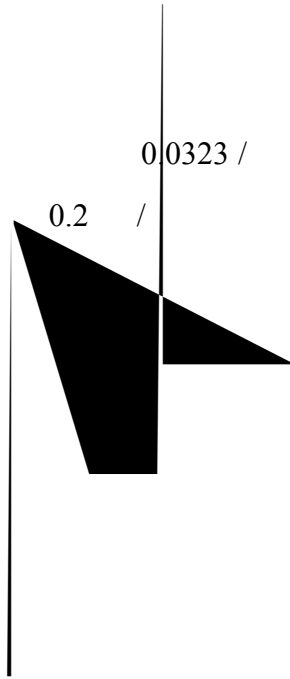

10
0.13 /

									0.
									0.1 1
									.
									2.0
					-1				
3 1 -2020					2021				
1						/		00-	- 3 .
2						/		00-	- 10.
3						/	2	00- 2	- 0.110
						/	1	00- 1	-
					3 1 -2 020	/	0	2 2-001- 0	0.
						/		00-0 1	0.1 1
					2021		01	31-001- 01	.
							01	31-001- 01	2.0
								31-001- 0	
					-1				

1			00-0 1-	0.1 1				0	/
2		01	31-001-01	.				30	
3		01	31-001-01 31-001-0	2.0				30	

10⁻²

1 -2001

2

-1

1				-	3 .
2				-	10.
3				00- - 2	0.110
				00- - 1	
				2 2-001-0	0.
				00-0 1-	0.1 1
				31-001-01	.
				31-001-01	2.0

3

2

1 -2020

10²

1 -2001

0.1 1 /

100 /

1

0. 2

0. 2

. /

100 /

0. 2

2. 2

2 /

0. 2

3. 2

2

1 -2001

3

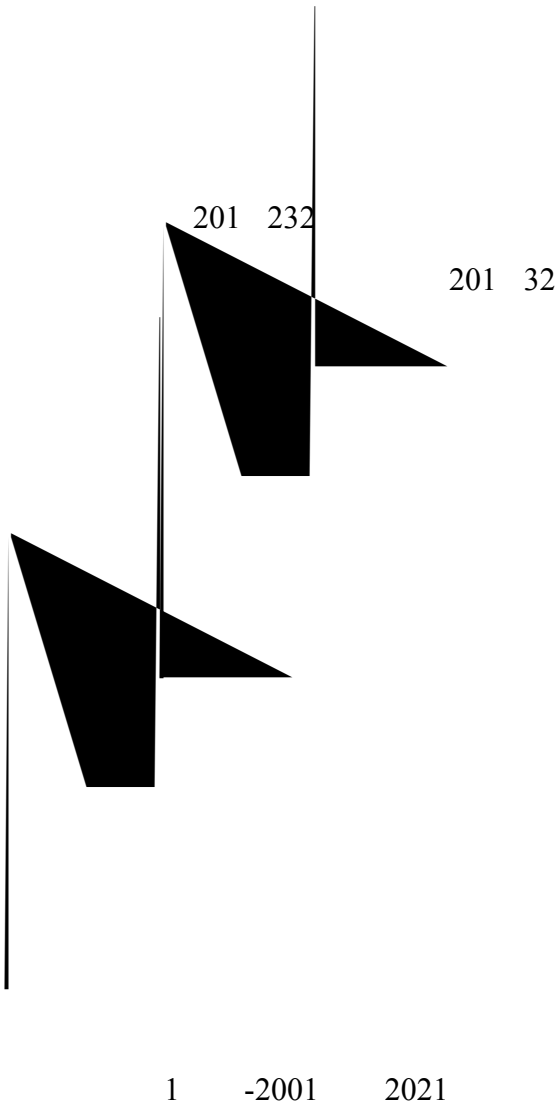

(1 -2020)

1 -2001 2013

1

.

1 -2020

1 2.2-1

10²

(1 -2001)

()

1 -2001

100%

2

201 32

1



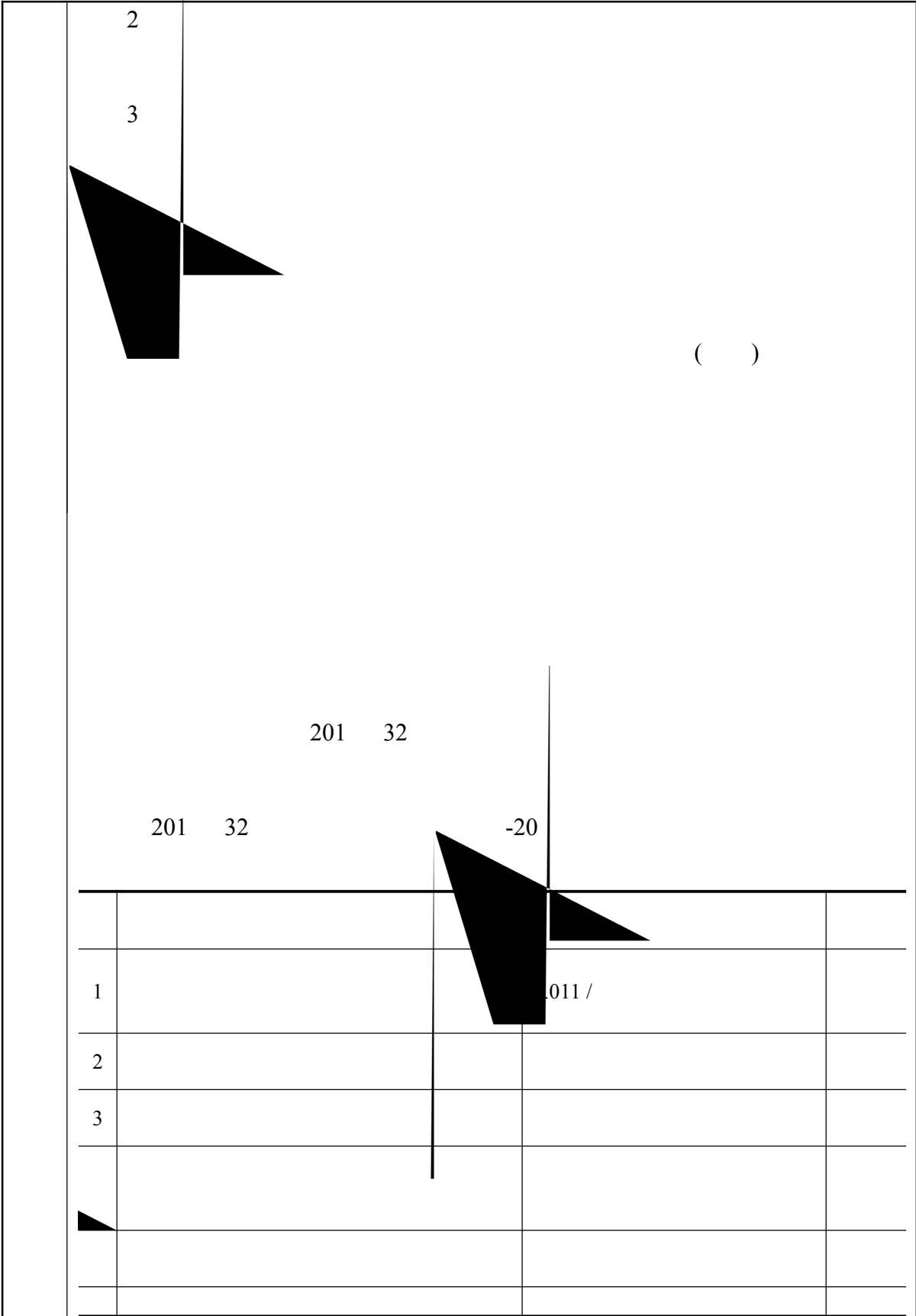

-

-

10-201

1 1

1

-23



		10^{-10} /
		10^{-} /
		1 -2001
	2	
	1	
		1 -201
		-2



	1		3																				
1	+																						
2																							
3																							
+																							
$Q = \frac{q_1}{Q_1} + \frac{q_2}{Q_2} + \dots + \frac{q_n}{Q_n}$																							
1	2																						
1	2																						
1																							
1	1	10	2 10																				
		100	3 100																				
<table border="1" style="width: 100%; border-collapse: collapse;"> <tr> <td style="width: 33%;"></td> <td style="width: 33%; text-align: center;">0.0</td> <td style="width: 33%;"></td> <td style="width: 33%; text-align: center;">0.01</td> </tr> <tr> <td></td> <td style="text-align: center;">0.03</td> <td style="text-align: center;">00</td> <td style="text-align: center;">0.0000</td> </tr> <tr> <td></td> <td style="text-align: center;">0. 1</td> <td style="text-align: center;">100</td> <td style="text-align: center;">0.00 1</td> </tr> <tr> <td></td> <td></td> <td></td> <td style="text-align: center;">0.10 1</td> </tr> <tr> <td></td> <td></td> <td style="text-align: center;">1</td> <td style="text-align: center;">-201 .2</td> </tr> </table>					0.0		0.01		0.03	00	0.0000		0. 1	100	0.00 1				0.10 1			1	-201 .2
	0.0		0.01																				
	0.03	00	0.0000																				
	0. 1	100	0.00 1																				
			0.10 1																				
		1	-201 .2																				

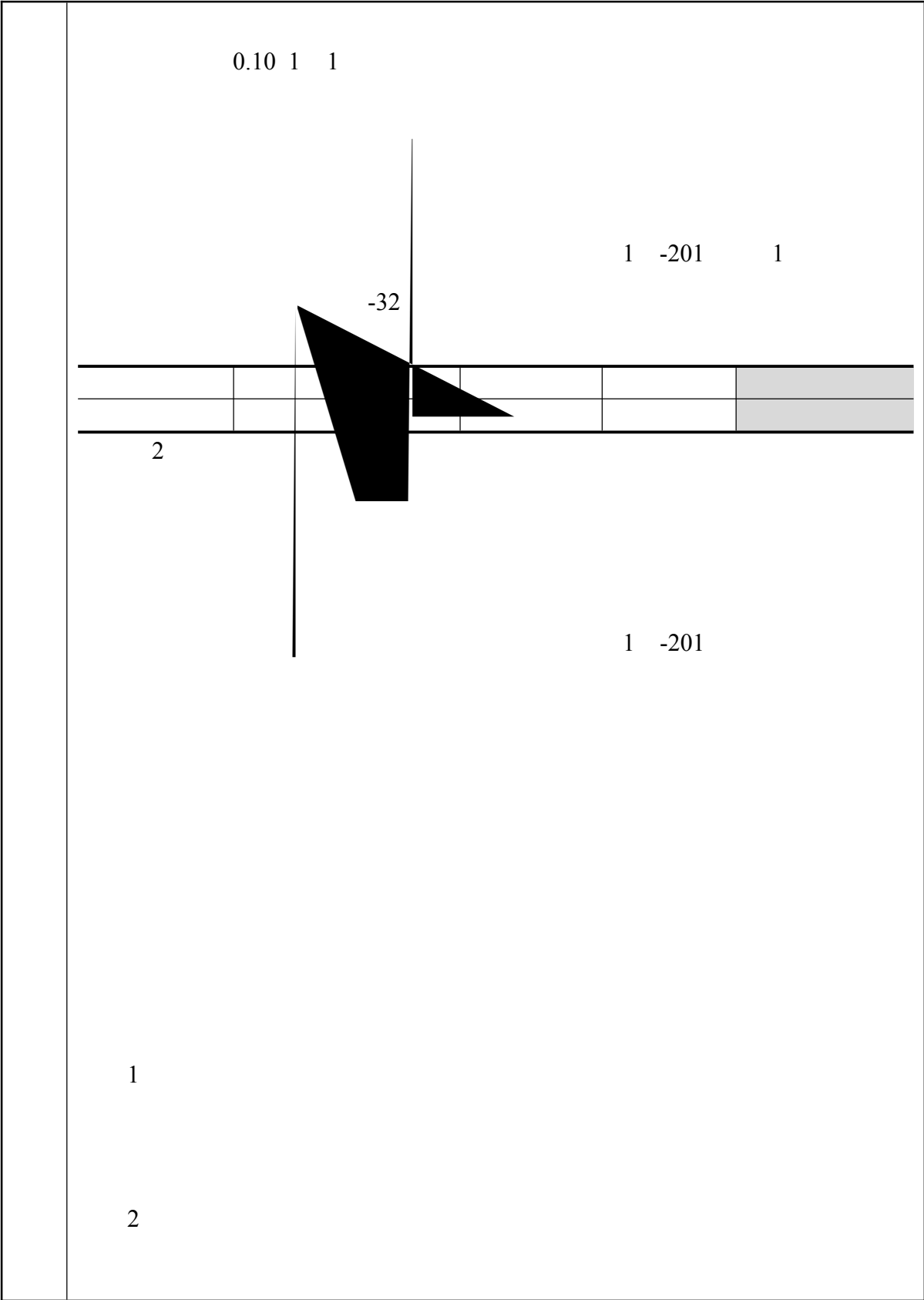

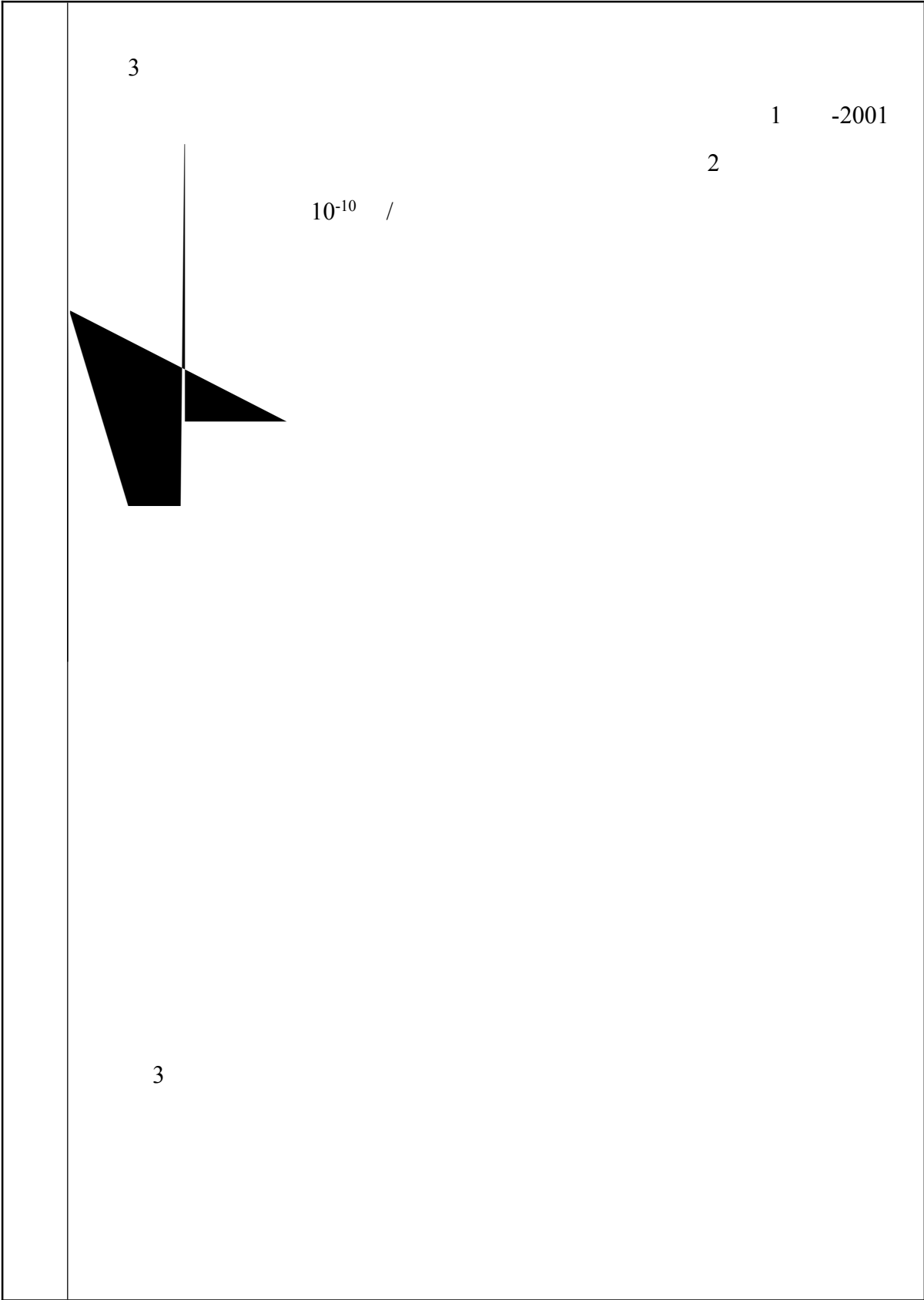

									1
		11	.	2		32 012	.		
									/

五、 境保 单

	()/			
	-01/			1 3-2001
	/			1 2 -1
	1#/			-1 / 31 2-201 1
	2#/		/	/
		()		123 -200 3
	/	/	/	/
	<p>10²,</p> <p>1 -2001</p> <p>202 -2012</p> <p>201 32</p> <p>2</p> <p>1 -2001 2013</p> <p>3 2021 1</p> <p>1 -2020</p>			

	/

六、

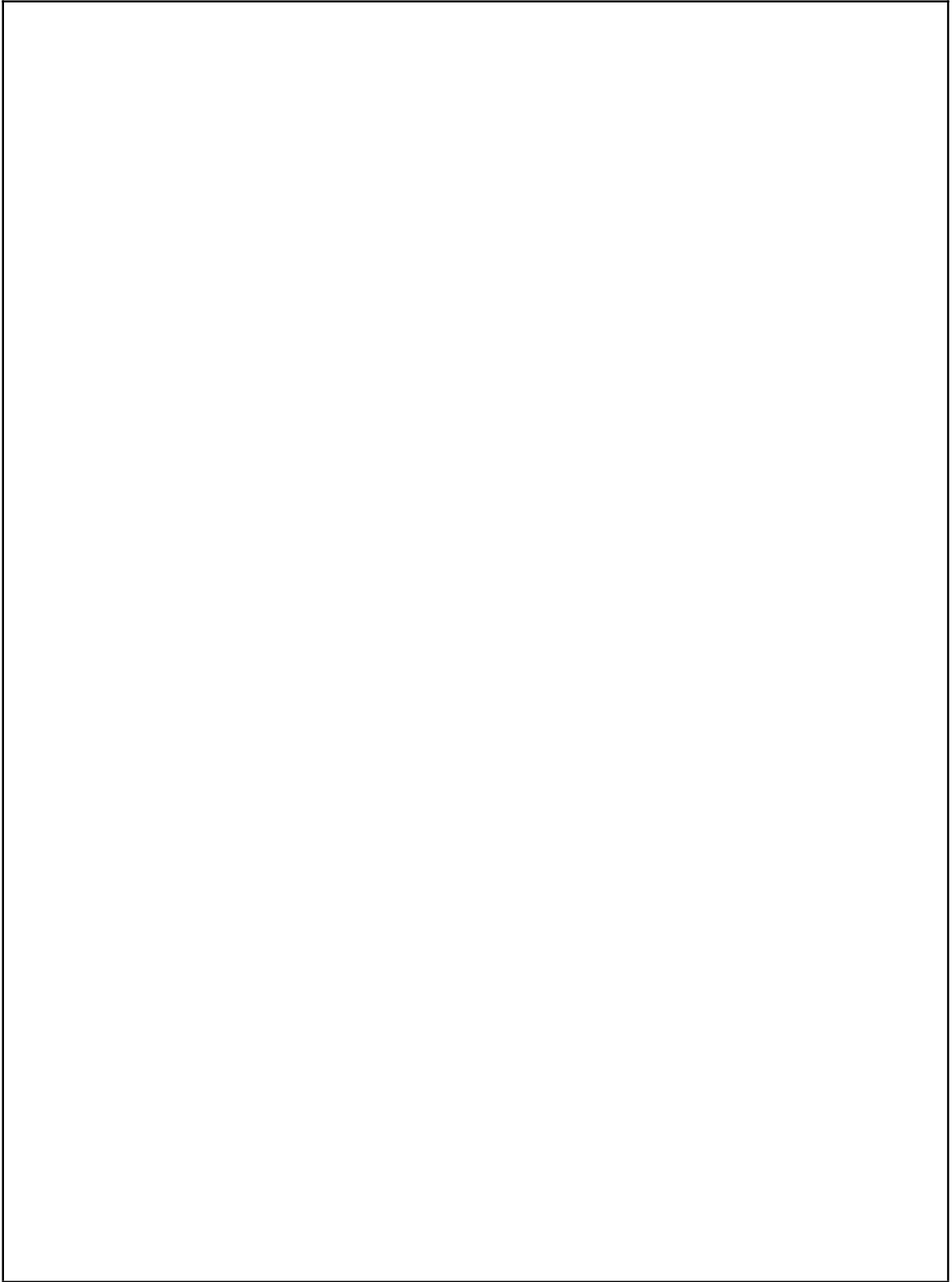

建

分	名 (/)	工 (固体 产)	工 可	在 工 (固体 产)	(固体 产)	以 削 (减 不填)	全厂 后 产 (固体)	变化
		/	/	/	0.00 1	/	0.00 1	0.00 1
	(3/)	/	/	/	2	/	2	2
		/	/	/	1.3 1	/	1.3 1	1.3 1
		/	/	/	0.	/	0.	0.
		/	/	/	0.1 3	/	0.1 3	0.1 3
		/	/	/	0.101	/	0.101	0.101
		/	/	/	0.032	/	0.032	0.032
		/	/	/	0.032	/	0.032	0.032
		/	/	/	2. 10 ¹⁰	/	2. 10 ¹⁰	2. 10 ¹⁰
		/	/	/	3 .	/	3 .	3 .

		/	/	/	10.	/	10.	10.
		/	/	/	0.110	/	0.110	0.110
		/	/	/	0.	/	0.	0.
		/	/	/	0.1 1	/	0.1 1	0.1 1
		/	/	/	.	/	.	.
		/	/	/	2.0	/	2.0	2.0

+ + - -

